

CENTER VESSEL ON 2 SUPPORTS AT SPANS "P"  
 3 SUPPORTS ARE REQUIRED FOR LENGTHS 4 AND OVER

- NOTES:
- DIMENSIONS IN MILLIMETERS(MM).
  - DIMENSIONS FOR REFERENCE ONLY.
  - SPECIFICATIONS SUBJECT TO CHANGE WITHOUT NOTICE.
  - MAERIALS MAY DIFFER BASED ON REQUIREMENT.

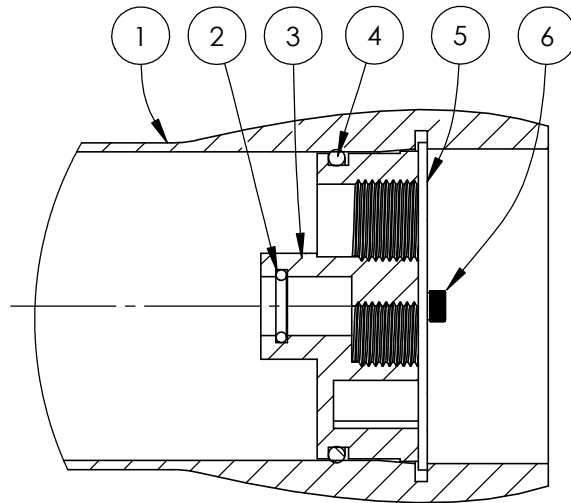

SECTION THROUGH END CLOSURE

Shell Element Code	L Span mm	S Shell Dia OD mm	D Bell Dia OD mm
1	1204	115	143
2	2220	115	143
3	3237	115	143
4	4253	115	143
5	5270	115	143

**MODEL ALFA AEROSOL 40-E**

Manufactured By:

