

CENTER VESSEL ON 2 SUPPORTS AT SPANS "P"
 3 SUPPORTS ARE REQUIRED FOR LENGTHS 4 AND OVER

- NOTES:
- DIMENSIONS IN MILLIMETERS(MM).
 - DIMENSIONS FOR REFERENCE ONLY.
 - SPECIFICATIONS SUBJECT TO CHANGE WITHOUT NOTICE.
 - MAERIALS MAY DIFFER BASED ON REQUIREMENT.

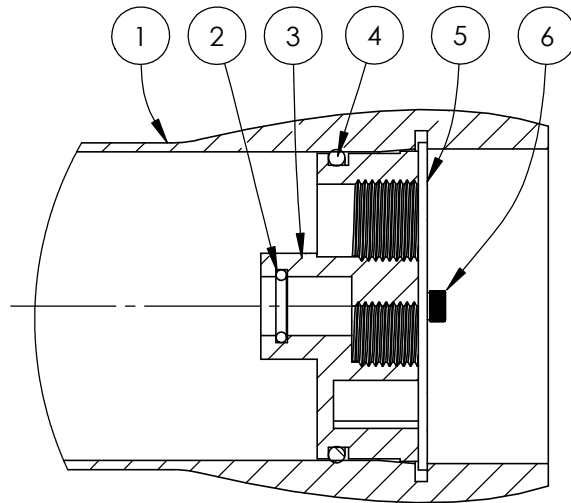

SECTION THROUGH END CLOSURE

Shell Element Code	L Span mm	S Shell Dia OD mm	D Bell Dia OD mm
1	1164	108	130
2	2180	108	130
3	3197	108	130
4	4213	108	130
5	5230	108	130

MODEL ALFA AEROSOL 40-E

Manufactured By:



DWG REF	QTY	DESCRIPTION	MATERIAL
①	1	FRP Shell	Filament Wound Composite (FRP)
②	2	Inter connector seal	Silicon O Ring
③	2	EndCap	Engineering ThermoPlastic
④	2	EndCap Seal	Silicon O Ring
⑤	4	Lockplate	Stainless Steel 304
⑥	4	LockPlate Screw	M6 - SS 304